

AD 2. AERODROMES

FYWH AD 2.1 AERODROME LOCATION INDICATOR AND NAME

FYWH - Hosea Kutako International Airport, Windhoek

FYWH AD 2.2 AERODROME GEOGRAPHICAL AND ADMINISTRATIVE DATA

1.	ARP co-ordinates and site at AD	222852.32S 0172813.80E Intersection of RWY 08/26 and 16/34
2.	Direction and distance from (city)	080°/24.3 NM East of Windhoek
3.	Elevation/reference temperature	5 643 FT/35 °C
4.	Geoid undulation at AD ELEV PSN	102 FT (30 M)
5.	MAG VAR/annual change	12° W (2020) / 0.02° decreasing
6.	Name of aerodrome operator, address, telephone, telefax numbers, e-mail address, AFS address and, if available, website address	Namibia Airports Company Limited Hosea Kutako International Airport P.O. Box 1 WINDHOEK NAMIBIA Mr. Alexander Gairiseb: Senior Airport Manager Contact Details Tel: +264 61 295 5601, Fax: NIL Cell: +264 81 143 4740 (during or after hours) E-mail: gairiseba@airports.com.na Website: www.airports.com.na ATC Tel: +264 62 702 490/1/2/3 Fax: +264 62 702 499 NCAA Fax: +264 61 702 099 AFS: FYWHYDYX
7.	Types of traffic permitted (IFR/VFR)	IFR/VFR
8.	Remarks	NIL

FYWH AD 2.3 OPERATIONAL HOURS

1.	<i>AD Administrator</i>	MON-SUN: 0300-1930
2.	<i>Customs and immigration</i>	As AD Administration
3.	<i>Health and sanitation</i>	As AD Administration
4.	<i>AIS briefing office</i>	NIL
5.	<i>ATS reporting office (ARO)</i>	NIL
6.	<i>MET briefing office</i>	H24
7.	<i>ATS</i>	H24
8.	<i>Fuelling</i>	As AD Administration
9.	<i>Handling</i>	As AD Administration
10.	<i>Security</i>	H24
11.	<i>De-icing</i>	NIL
12.	<i>Remarks</i>	See section AD 2.20 for Airport Regulations. AIS Briefing Office located at FYWE

FYWH AD 2.4 HANDLING SERVICES AND FACILITIES

1.	<i>Cargo-handling facilities</i>	Forklift capacity 3 tons, 2.5 tons Double Container pallets/ dolleys, Cargo Dolleys, Single container Dolleys, Wooden Panel Baggage cart, 1 High-Low Loader (TLD), 1 Lower –deck loader (TLD) 3 Baggage Loading belts (NBL), 3 Ground Power Units (TLD), /1 Passenger Aid Unit (PAU) ,2 Nonmotorized steps-Wide body, 2 Narrow body steps Nonmotorized, 1 Motorized Steps-Wide body, 1 Toilet service, 1 water cart services, 2 Tractors, (TLD) 1 Nissan Tractor
2.	<i>Fuel/oil types</i>	Jet A1
3.	<i>Fuelling facilities/capacity</i>	Hydrant refueling system and Bowser of 18,000L. One truck with capacity of 18,000L with a floor of 900 litres/min
4.	<i>De-icing facilities</i>	NIL
5.	<i>Hangar space for visiting aircraft</i>	NIL
6.	<i>Repair facilities for visiting aircraft</i>	NIL
7.	<i>Remarks</i>	NIL

FYWH AD 2.5 PASSENGER FACILITIES

1.	<i>Hotels</i>	Hotels in City and lodges located near the AD.
2.	<i>Restaurants</i>	On AD and in the city.
3.	<i>Transportation</i>	Airport Shuttles, taxi service and Car hire
4.	<i>Medical facilities</i>	First aid, ambulance on AD. Hospital in city ± 50 KM
5.	<i>Bank and post office</i>	Foreign Exchange and ATM open with AD Administration hours, NIL Post Office.
6.	<i>Tourist office</i>	NIL
7.	<i>Remarks</i>	NIL

FYWH AD 2.6 RESCUE AND FIRE FIGHTING SERVICES

1.	<i>AD category for fire fighting</i>	CAT 9
2.	<i>Rescue equipment</i>	3 x Fire Tenders 1 x Ambulance 700 000L water reservoir 11 250L AFFF (Foam- Tridol "S" 6%) 700KG Dry Chemical Powder Hydrants (18)
3.	<i>Capability for removal of disabled aircraft</i>	Removal of disabled aircraft is the responsibility of the airline or registered owner or aircraft operator. Disabled aircraft removal coordinator: Mr. Alexander Gairiseb Senior airport manager Tel: +264 61 295 5601 Fax: NIL Cell: +264 81 143 4740 (during and after hours) Email: gairiseba@airports.com.na Website: www.airports.com.na
4.	<i>Remarks</i>	Rescue and Fire Fighting hours of operations are 24HR

FYWH AD 2.7 SEASONAL AVAILABILITY - CLEARING

1	<i>Types of clearing equipment</i>	NIL
2	<i>Clearance priorities</i>	NIL
3	<i>Remarks</i>	NIL

FYWH AD 2.8 APRONS, TAXIWAYS AND CHECK LOCATIONS/POSITIONS DATA

1.	<i>Apron designation, surface, and strength</i>	Surface: Asphalt Strength: PCN 100/F/B/W/T Surface: Concrete Strength: PCN 65/R/B/W/T Surface: Interlocks Strength: PCN NIL Info available
2.	<i>Taxiway designation, width, surface, and strength</i>	Taxiway: Parallel Taxiway Width: 23 M Surface: Asphalt Strength: PCN 65/F/B/W/T TWY Intersection A, Width 23 M, Asphalt, PCN 65/F/B/W/T TWY Intersection B, Width 23 M, Asphalt, PCN 65/F/B/W/T TWY Intersection C, Width 23 M, Asphalt, PCN 65/F/B/W/T TWY Intersection D, Width 23 M, Asphalt, PCN 65/F/B/W/T TWY Intersection E, Width 23 M, Asphalt, PCN 65/F/B/W/T TWY Intersection F, Width 23 M, Asphalt, PCN 65/F/B/W/T
3.	<i>Altimeter checkpoint location and elevation</i>	NIL
4.	<i>VOR checkpoints</i>	Elevation: 5643 FT Location: At Holding Point Bravo 114.5 MHz
5.	<i>INS checkpoints</i>	NIL
6.	<i>Remarks</i>	NIL

FYWH AD 2.9 SURFACE MOVEMENT GUIDANCE AND CONTROL SYSTEM AND MARKINGS

1.	<i>Use of aircraft stand ID signs, TWY guide lines and visual docking/ parking guidance system of aircraft stands</i>	NIL aircraft stand ID signs and markings. Taxiing guidance signs at all intersections with TWY and RWY and at all holding positions. Aircraft TWY Guidelines available. Pilots to follow the marshaller.
2.	<i>RWY and TWY markings and LGT RWY markings:</i>	RWY markings: Designation, Threshold, Touch Down Zone, Aiming Points, Side-Stripe markings, Centre line. RWY LGT: Runway Edge Lights, Threshold Lights, Approach Lights, Runway End Lights. TWY markings: Taxiway edge marking, Centre line and Holding Positions at all TWY/RWY intersections marked. TWY LGT: Taxiway Edge Lights.

3.	Stop bars	NIL
4.	Other runway protection measures	NIL
5.	Remarks	See also section AD 2.20 for taxing and parking information

FYWH AD 2.10 AERODROME OBSTACLES

<i>In Area 2a</i>					
<i>OBST ID/ Designation</i>	<i>OBST Type</i>	<i>OBST position</i>	<i>ELEV/HGT(M)</i>	<i>Markings / Type, Colour</i>	<i>Remarks</i>
a	b	c	d	e	f
AMS E_N	Equipment	222847.30S 0172808.30E	5623	NIL	NIL
MET STATION_08	Equipment	222917.30S 0172703.00E	5669	LGT	NIL
WIND SENSOR_08	Equipment	222921.20S 0172709.40E	5692	NIL	NIL
WINDSOCK08	Equipment	222920.00S 0172658.40E	5666	Marked LGT	NIL
WINDSOCK34	Equipment	222859.00S 0172822.00E	5587	Marked LGT	NIL

<i>In Area 2b</i>					
<i>OBST ID/ Designation</i>	<i>OBST Type</i>	<i>OBST position</i>	<i>ELEV/HGT</i>	<i>Markings / Type, Colour</i>	<i>Remarks</i>
a	b	c	d	e	f
ILS CONTAINER	Equipment	222929.40S 0172650.30E	5659	Marked LGT	NIL
WATER TANK	TANK	222950.90S 0172735.60E	5741	NIL	NIL
LOCALIZER 26	Equipment	222927.30S 0172649.30E	5656	Marked	NIL
ILS MONITOR 26	Equipment	222926.10S 0172651.80E	5653	LGT	NIL

<i>In Area 2c</i>					
<i>OBST ID/ Designation</i>	<i>OBST Type</i>	<i>OBST position</i>	<i>ELEV/HGT (FT)</i>	<i>Markings / Type, Colour</i>	<i>Remarks</i>
a	b	c	d	e	f
MTC TWR	Tower	222931.40S 0172728.90E	5748	LGT	NIL
POWER COM TWR	Tower	222929.00S 0172749.80E	5722	Marked LGT	NIL
RESERVOIR	Tower	222940.80S 0172712.10E	5725	Marked LGT	Marked
RX MAST1	Equipment	222908.70S 0172850.90E	5679	NIL	NIL
RX MAST2	Equipment	222910.40S 0172850.90E	5686	NIL	NIL
RX MAST3	Equipment	222910.40S 0172849.00E	5682	NIL	NIL
RX MAST4	Equipment	222907.70S 0172849.00E	5630	NIL	NIL
J FUEL TANK_1	Tank	222918.60S 0172742.30E	5666	NIL	NIL
J FUEL TANK_2	Tank	222919.40S 0172742.60E	5669	NIL	NIL
TXT MAST_1	Equipment	222935.70S 0172726.00E	5758	NIL	NIL
TXT MAST_2	Equipment	222934.00S 0172725.30E	5748	NIL	NIL
TXT MAST3	Equipment	222933.30S 0172727.00E	5748	NIL	NIL
TXT MAST_4	Equipment	222934.90S 0172728.10E	5755	NIL	NIL
VOR WHV_N	Equipment	222838.50S 0172814.10E	5614	Marked LGT	NIL
RADAR	Equipment	222938.00S 0172726.20E	5830	NIL	NIL
ARB	Equipment	222940.80S 0172712.10E	5719	LGT	NIL

<i>In Area 3</i>					
<i>OBST ID/ Designation</i>	<i>OBST Type</i>	<i>OBST position</i>	<i>ELEV/HGT (FT)</i>	<i>Markings / Type, Colour</i>	<i>Remarks</i>
a	b	c	d	e	f
STEEL TWR	Tower	222915.60S 0172742.10E	5670.3	NIL	NIL
AMS E_N	Equipment	222847.30S 0172808.30E	5622.4	NIL	NIL
C_TWR_A	Tower	222910.60S 0172751.20E	5672.9	LGT	NIL
C_TWR_B	Tower	222910.60S 0172751.20E	5695.9	LGT	NIL
FLOOD LT1_N	Pole	222915.90S 0172738.80E	5707.0	LGT	NIL
FLOOD LT2_N	Pole	222914.90S 0172740.90E	5705.4	LGT	NIL
FLOOD LT3_N	Pole	222914.00S 0172742.90E	5704.7	LGT	NIL
FLOOD LT4_N	Pole	222912.90S 0172745.30E	5705.4	LGT	NIL
FLOOD LT5_N	Pole	222911.90S 0172747.50E	5704.4	LGT	NIL
FLOOD LT6_N	Pole	222910.80S 0172749.80E	5703.7	LGT	NIL
FLOOD LT7_N	Pole	222909.80S 0172752.10E	5704.1	LGT	NIL
FLOOD LT8_N	Pole	222908.70S 0172754.30E	5703.7	LGT	NIL
FLOOD LT9_N	Pole	222907.70S 0172756.60E	5700.8	LGT	NIL
MET STATION_08	Equipment	222917.30S 0172703.00E	5670.3	LGT	NIL
NAMPOWER STEEL TOWERS	Transmission lines	223209.20S 0172130.60E, 223157.80S 0172139.60E, 223145.40S 0172149.50E, 223131.00S 0172200.90E	6070	Marked, red and white.	Fitted with aerial balls

FYWH AD 2.11 METEOROLOGICAL INFORMATION PROVIDED

1.	<i>Associated Met office</i>	Windhoek
2.	<i>Hours of service MET office outside hours</i>	H24
3.	<i>Office responsible for TAF preparation Periods of validity</i>	Windhoek 9, 18 HR
4.	<i>Type of landing forecast Interval of issuance</i>	TREND
5.	<i>Briefing/consultation provided</i>	P, T
6.	<i>Flight documentation Language(s) used</i>	PL, TB English
7.	<i>Charts and other information available for briefing or consultation</i>	S3, U85, U7, U5, U3, U2, P5
8.	<i>Supplementary equipment available for providing information</i>	NIL
9.	<i>ATS units provided with information</i>	Windhoek FIC, Cape Town RCC, Johannesburg RCC
10.	<i>Additional information (limitation of service, etc.)</i>	NIL

Mean daily maximum and minimum temperatures (°C) for each month of the year												
	JAN	FEB	MAR	APR	MAY	JUN	JUL	AUG	SEP	OCT	NOV	DEC
Max	31,3	28,7	27,6	26,1	23,1	20,4	21,2	24,1	26,9	29,6	29,6	30,2
Min	17,7	16,3	14,4	9,8	5,7	2,8	2,4	5,2	8,5	12,3	15,3	16,4
Mean pressure for each month of the year at approximately the times of MAX and MIN temperatures in hPa												
Max	827,7	829,0	829,7	830,0	831,1	832,3	833,2	832,1	831,0	829,3	829,3	828,3
Min	828,9	829,6	831,0	831,4	832,4	833,6	834,8	833,8	832,8	830,9	830,3	829,4

FYWH AD 2.12 RUNWAY PHYSICAL CHARACTERISTICS

<i>Designations RWY NR</i>	<i>TRUE BRG</i>	<i>Dimensions of RWY (M)</i>	<i>Strength of the pavement classification number (PCN) and surface of RWY and SWY</i>	<i>THR coordinates RWY end coordinates THR geoid undulation</i>	<i>THR Elevation and Highest Elevation of TDZ of Precision APPRWY</i>
1	2	3	4	5	6
08	063.37°	4569 x 45	76/F/B/W/T Asphalt NIL SWY	THR / RWY end 222923.08S 0172658.43E GUND 102 FT	THR 5643 FT
26	243.37°	4569 x 45	76/F/B/W/T Asphalt NIL SWY	THR 222817.12S 0172921.61E RWY end 222817.12S 0172921.59E GUND 102 FT	THR 5500.3 FT TDZ 5507.5 FT
16	141.09°	1523 x 30	100/F/B/W/T Asphalt NIL SWY	THR coordinates 222839.65S 0172808.58E RWY end coordinates 222839.65S 0172808.58E GUND 102 FT	THR 5574 FT
34	321.09°	1523 x 30	100/F/B/W/T Asphalt NIL SWY	THR / RWY end 222918.22S 0172841.99E GUND 102 FT	THR 5564 FT

<i>Designation RWY NR</i>	<i>Slope of RWY-SWY</i>	<i>SWY Dimensions (M)</i>	<i>CWY Dimensions (M)</i>	<i>Strip Dimensions (M)</i>	<i>Dimensions of runway end safety areas</i>
1	7	8	9	10	11
08	RWY-0.9 % SWY NIL	NIL	165	4688 x 280	240 x 180
26	RWY-0.9 % SWY NIL	NIL	120	4688 x 280	240 x 180
16	RWY-0.2 % SWY NIL	NIL	120	1643 x 150	240 x 120
34	RWY-0.2 % SWY NIL	NIL	120	1643 x 150	240 x 120

<i>Designation RWY NR</i>	<i>Location and description of engineering material arresting system (EMAS)</i>	<i>OFZ</i>	<i>Remarks</i>
1	12	13	14
08	NIL	NIL	NIL
26	NIL	NIL	NIL
16	NIL	NIL	NIL
34	NIL	NIL	NIL

FYWH AD 2.13 DECLARED DISTANCES

<i>RWY Designator</i>	<i>TORA (M)</i>	<i>TODA(M)</i>	<i>ASDA (M)</i>	<i>LDA (M)</i>	<i>Remarks</i>
1	2	3	4	5	6
08	4569	4734	4569	4569	NIL
26	4569	4689	4569	4569	NIL
16	1523	1643	1523	1523	NIL
34	1523	1643	1523	1523	NIL

FYWH AD 2.14 APPROACH AND RUNWAY LIGHTING

<i>RWY Designator</i>	<i>APCH LGT type LEN INTST</i>	<i>THR LGT colour WBAR</i>	<i>VASIS (MEHT) PAPI</i>	<i>TDZ, LGT, LEN</i>	<i>RWY Centre line LGT length, spacing, colour, INTST</i>
1	2	3	4	5	6
08	SALS, 420 M, LIH	Green	PAPI 3°	NIL	NIL
26	PALS, 900 M, LIH	Green	PAPI 3°	NIL	NIL
16	LIH	Green	NIL	NIL	NIL
34	LIH	Green	PAPI 3°	NIL	NIL

<i>RWY edge LGT LEN, spacing colour INTST</i>	<i>RWY End LGT colour WBAR</i>	<i>SWY LGT LEN (M) colour</i>	<i>Remarks</i>
7	8	9	10
4569 M/57.50 M, White/LIH	Red	NIL	Last 600 M of RWY is amber
4569.193 M/57.50 M, White/LIH	Red	NIL	NIL
1525 M/57.50 M, White/LIH	Red	NIL	PAPI RWY 34 U/S
1525 M/57.50 M, White/LIH	Red	NIL	NIL

FYWH AD 2.15 Other lighting, secondary power supply

1.	<i>ABN/IBN location, characteristics and hours of operation</i>	700 M South of THR RWY 08 ABN FLG G/W 24 HR
2.	<i>LDI location and LGT Anemometer location and LGT</i>	LDI: NIL Anemometer: 75 M W of THR RWY 34, lighted.
3.	<i>TWY edge and centre line lights and stop bars (if any)</i>	Edge: All TWY Centre line: NIL
4.	<i>Secondary power supply/switch-over time</i>	Secondary power to all essential loads Switch-over time +15 seconds
5.	<i>Remarks</i>	NIL

FYWH AD 2.16 HELICOPTER LANDING AREA

1	Coordinates TLOF or THR of FATO Geoid undulation	NIL
2	TLOF and/or FATO elevation M/FT	NIL
3	TLOF and FATO area dimensions, surface, strength, marking	NIL
4	True BRG of FATO	NIL
5	Declared distance available	NIL
6	APP and FATO lighting	NIL
7	Remarks	NIL

FYWH AD 2.17 ATS AIRSPACE

1.	<i>Designation and lateral limits</i>	Windhoek CTR: Lateral Limits: 222105.80S 0172531.48E – clockwise along the arc of a circle, radius 8NM centred at 222817.21S 0172921.40E – 223119.04S 0173721.14E – 223707.98S 0172443.90E – clockwise along the arc of a circle, radius 8NM centred at 222923.02S 0172658.54E – 222211.54S 0172308.70E to point of origin
2.	<i>Vertical limits</i>	SFC to 7500FT AMSL
3.	<i>Airspace classification</i>	C
4.	<i>ATS unit call sign Language(s)</i>	Windhoek Tower English
5.	<i>Transition altitude</i>	10 000 FT MSL
6.	<i>Remarks</i>	<ol style="list-style-type: none"> Speed restrictions apply within Windhoek TMA. Refer FYWH AD 2.22 Flight Procedures Use FYWH QNH within lateral confines of Windhoek TMA at and below 10 000 FT AMSL. Refer ENR 2.1-3 Note 2 All traffic operating in Class G airspace beneath FYWH TMA, excluding FYD130, must monitor and/or contact Windhoek Approach FREQ 120.5 MHz.

FYWH AD 2.18 ATS COMMUNICATION FACILITIES

<i>Service designation</i>	<i>Call sign</i>	<i>Frequency</i>	<i>Hours of operation</i>	<i>Remarks</i>
1	2	3	4	5
APP	Windhoek Approach	120.5 MHz	H24	NIL
TWR	Windhoek Tower	118.1 MHz	H24	NIL
ATIS	Windhoek ATIS	126.2 MHz	H24	Daily 0600 – 1900 Operational 50NM radius around the airport on FREQ 126.2 MHz or TEL +264 81 3323509

FYWH AD 2.19 RADIO NAVIGATION AND LANDING AIDS

Type of aid, CAT of ILS/MLS (for VOR/ILS/MLS give VAR)	ID	Frequency	Hours of Operation	Position of transmitting antenna co-ordinates	Elevation of DME transmitting antenna	Remarks
1	2	3	4	5	6	7
VOR/DME (12°W/2019)	WHV	114.5 MHz CH92X	H24	222838.52S 0172814.07E	5613 FT	NIL
UHF DME	WHV	Tx 1179 MHz Rx 1116 MHz	H24	222838.52S 0172814.07E	5613.1 FT	Channel 92 X co-axially co-located with VOR
LOC 26 (12°W/2019) ILS CAT I (12°W or 256°)	WD	110.3 MHz	H24	222927.30S 0172649.26E	5650 FT	NIL
GP 26		335.0 MHz	H24	222817.78S 0172910.74E	5540 FT	3°, RDH 49 FT
RNP APCH	N/A	1575.42MHz	H24	N/A	N/A	Transmitting antennas are satellite based.

FYWH AD 2.20 LOCAL AERODROME REGULATIONS

1. Airport regulations

1.1. Hazard, incident, and Accident Reporting.

All safety hazards, incidents, and accidents to be reported to FYWH Fire Station, Safety Office and emailed to hkiasafety@airports.com.na.

1.2. Reflective Jackets

All pilots and crews operation at Hosea Kutako International Airport, airside must wear a lime and silver reflective stripes jacket depicting their airlines/aircraft operator on the rear side of the jacket for identification and safety precaution measure.

1.3. New Aircraft Operating at HKIA

Aircraft Operators intending to operate an aircraft for the first time at HKIA must apply in writing through the Senior Airport Manager and complete the new Aircraft Application form and may only operate the new aircraft upon approval by the NAC.

1.4. Airport Charges

1.4.1. After Hour Operations

Aircraft wishing to operate outside the operation hours should apply 48HR in advance to APM and a surcharge of N\$10,904 per hour thereof will apply. This does not apply to emergency aircraft operations.

Operators are advised to operate within the airport operational hours due to additional stakeholder's services required and costs associated thereto.

1.4.2. Landing/Parking and Passenger Fees

All unscheduled and charters flight to effect payment directly to NAC upon arrival and before departure and not to any third parties, Payment can be done at Apron Office located at the Fire Station.

1.5. Aircraft Ground Handling

Aircraft Operators are to make arrangement only with the licensed ground handling operator at HKIA.

1.6. Circuit Altitude:

- a) Turbine-powered aircraft 7 000 FT ALT
- b) Reciprocating engine powered aircraft 6500 FT ALT.

2. Taxiing to and from stands

2.1. Landing

From runway 26: follow parallel taxiway via intersection Echo/Charlie or Bravo exit to apron.

From runway 08: follow parallel taxiway via intersection Bravo/ Charlie or Echo exit to apron.

From runway 16: follow parallel taxiway via Delta exit to apron.

From runway 34: follow parallel taxiway via Delta exit to apron.

2.2. Take-off

From the apron to holding point Alpha runway 08: follow parallel taxiway leading to holding point Bravo enter runway 08/26 to the turning circle Alpha runway 08.

From the apron to holding point Bravo runway 08: follow parallel taxiway to holding point Bravo.

From the apron to holding point Charlie runway 08: follow parallel taxiway to holding point Charlie.

From the apron to holding point Delta runway 26: follow parallel taxiway leading to holding point Delta.

Runway 26: follow parallel taxiway leading to intersection Delta.

From the apron to holding point Echo runway 26: follow parallel taxiway leading to Delta intersection, cross runway 16/34 leading to the holding point Echo.

From the apron to holding point Foxtrot runway 26: follow parallel taxiway leading to the Delta intersection, cross runway 16/34 leading to the holding point Echo enter Runway 08/26 to turning circle Foxtrot runway 26.

3. Parking area for small aircraft (general aviation)

There is no designated stands for the parking of small aircrafts. Pilots are strictly requested to adhere to the marshalling signals from the Marshaller.

No aircraft mooring points available at FYWH. ACFT mooring weights AVBL. 2X35Kg pairs, 3X50Kg pairs, 3X70Kg pairs. The key for the mobile trolley is available at the Apron Safety Office. Aircraft Operator responsible for returning mooring weights after use.

4. Parking area for helicopters

NIL

5. Apron – taxiing during winter conditions

NIL

6. Taxiing - Limitations

NIL

7. School and training flights - Technical test flights - Use of runways

Instrument training slot time required, including night flying. Phone Eros Briefing office on +264 61 702083 or obtain in person at the Briefing Office. Maximum 3 days in advance. Pilots must advise ATC prior to taxi of Slot Time Reference

Number (STRN) allocated at time of booking.

8. Helicopter traffic - Limitation

NIL

9. Removal of disabled aircraft from runways

The registered owner or aircraft operator will always retain complete responsibility for the removal of the disabled aircraft. All airline operators at FYWH are expected to have an aircraft recovery plan. For non-airlines operators at FYWH, the pilot or aircraft owner is responsible for the immediate removal and or disposal of the disabled aircraft.

Disabled aircraft removal coordinator:

Mr. Alexander Gairiseb

Senior Airport Manager

Tel: +264 61 295 5601

Fax: NIL

Cell:+264 81 143 4740 (during or after hours)

Email: gairiseba@airports.com.na

Website: www.airports.com.na

10. Limitations on the use of the aerodrome

10.1 Simultaneous Movement of Aircraft

Due to insufficient Safety Distances between the main runway and parallel taxiway centerlines, the simultaneous movement of aircraft is allowed as follows:

a) Allowable Simultaneous Movements

- CODE C or higher is allowed to take off or land provided the parallel taxiway is NOT occupied by ANY aircraft.
- The simultaneous use of the runway for a code A and B aircraft landing or taking off while a code D aircraft and lower is taxiing is acceptable.

b) Mixed Aircraft Operations (Departure holding points)

Any aircraft type is permitted to hold in the loop for departure at a distance of at least 90m from the runway centerline while another aircraft is landing on the same runway, in Visual Metrological Conditions (VMC) only.

c) Mixed Aircraft Operations (Taxi for departure):

This aircraft operation allow aircraft to taxi at the same time for an intersection or full-length departure using runway 08/26, provided that the aircraft taking the intersection ahead takes-off first.

d) Mixed Aircraft Operations (Landing-Roll Complete):

Any aircraft will be permitted to taxi from the apron once the landing aircraft (Code C, D and E) announces that landing roll is complete. All pilots in code C, D and E aircraft must announce to ATC once landing roll is complete.

e) Aircraft operational restrictions

When a CODE C aircraft or higher is landing or taking off no taxiing of aircraft on the parallel taxiway is permitted.

10.2 Preflight Altimeter Checkpoints

NAC has currently not established and thus not published the preflight altimeter check locations. The pre-flight altimeter checks are currently conducted on any position on the Apron. Pilots obtain the QNH from ATC, which is obtained from the Pressure Sensor of Meteorological Services.

10.3 Apron Markings

Airport Apron lead in lines are not commensurate with aircraft operations. There are no aircraft stand markings on FYWH apron. Pilots are to follow aircraft marshaller instructions.

FYWH AD 2.21 NOISE ABATEMENT PROCEDURES

NIL

FYWH AD 2.22 FLIGHT PROCEDURES

General:

Communication Failure Procedure

Aircraft should adhere to the procedures stipulated in ENR 1.5 Section 6 (ICAO Doc 4444 Chapter 15, 15.3). In addition, the relevant procedures below shall be applied by inbound aircraft.

If able contact ATC on telephone +264 61 702 290

For IFR Traffic

1. Squawk 7600
2. Approach clearance received and acknowledged:
Continue approach according to clearance.
3. No approach clearance received and acknowledged:
 - Maintain last assigned level received and acknowledged, but not below MSA.
 - Proceed via WHV VOR then via R050 WHV to intercept the 14DME arc to join the hold at IMPEP;
 - In IMPEP hold descent to 8000FT MSL.
 - Carry out instrument approach to the most suitable runway, or if EAT is received and acknowledged, leave IMPEP on EAT.
4. If issued with a STAR, refer to Communication Failure Procedure for the STAR being flown. Comply with all lateral, vertical and speed requirements of the STAR. Holding is not required when issued with a STAR, unless an EAT has been received and acknowledged including delays/holding for traffic management purposes.

For VFR traffic

- a) Squawk Code 7600
- b) Join overhead the aerodrome at 2000FT AGL
- c) Observe and join the Aerodrome traffic circuit
- d) Make all turns to the left whenever possible
- e) Land as soon as possible and report to the ATC

Speed Restriction

Speed restrictions within Windhoek TMA for arriving and departing aircraft, MAX IAS 250KT restriction applies at and below FL150. Speed is mandatory and must be complied with. ATC may vary the speeds for traffic management purposes.

FYWH AD 2.23 ADDITIONAL INFORMATION

Bird concentrations in the vicinity of the airport.

1. Concentration of birds around the runway and in the vicinity of the aerodrome, pilots and airport users to exercise caution.

FYWH AD 2.24 CHARTS RELATED TO HOSEA KUTAKO AERODROME

	Page
Aerodrome Chart – ICAO	AD 2-19
Area Chart – ICAO (Reserved)	AD 2-21
Standard Departure Chart – Instrument – ICAO EGMAS 1A, UTULO 1A RWY 08	AD 2-23
Narrative EGMAS 1A and UTULO 1A RWY 08	AD 2-24
Standard Departure Chart – Instrument – ICAO EGMAS 1B, UTULO 1B RWY 26	AD 2-25
Narrative EGMAS 1B, UTULO 1B RWY 26	AD 2-26
Standard Arrival Chart – Instrument – ICAO ATUPI 1A, AXODO 1A RWY 08	AD 2-27
Narrative ATUPI 1A, AXODO 1A RWY 08	AD 2-28
Standard Arrival Chart – Instrument – ICAO ATUPI 1B, AXODO 1B RWY 26	AD 2-29
Narrative ATUPI 1B, AXODO 1B RWY 26	AD 2-30
ATC Surveillance Minimum Altitude Chart – ICAO	AD 2-31
ATC Surveillance Minimum Altitude Coordinates	AD 2-32
Instrument Approach Chart – ICAO ILS or LOC RWY 26	AD 2-33
Data Code ILS or LOC RWY 26	AD 2-34
Instrument Approach Chart – ICAO CIRCLING VOR RWY 26	AD 2-35
Data Code Circling VOR RWY 26	AD 2-36
Instrument Approach Chart – ICAO RNP RWY 08	AD 2-37
Data Code RNP RWY 08	AD 2-38
Instrument Approach Chart – ICAO RNP RWY 26	AD 2-39
Data Code RNP RWY 26	AD 2-40
Visual Approach Chart – FYWH	AD 2-41
Visual Approach Chart – FYWE and FYWH	AD 2-43
Aerodrome Obstacle Chart - ICAO	AD 2-45

AERODROME CHART - ICAO

22°28'52.32"S
17°28'13.80"E

ELEV 5643 FT

WINDHOEK TWR 118.1
WINDHOEK APP 120.5
WINDHOEK ATIS 126.2

WINDHOEK/
HOSEA KUTAKO INTERNATIONAL AIRPORT

ELEVATION IN FEET
DIMENSION IN METRES
BEARINGS ARE MAGNETIC



ANNUAL CHANGE
OF CHANGE 0.02° E

RWY	DIRECTION	THR	BEARING STRENGTH
08	075°	22°29'23.0"S 017°26'58.4"E	76/F/B/W/T
26	255°	22°28'17.1"S 017°29'21.6"E	
16	152°	22°28'39.6"S 017°28'08.5"E	100/F/B/W/T
34	332°	22°29'18.2"S 017°28'41.9"E	

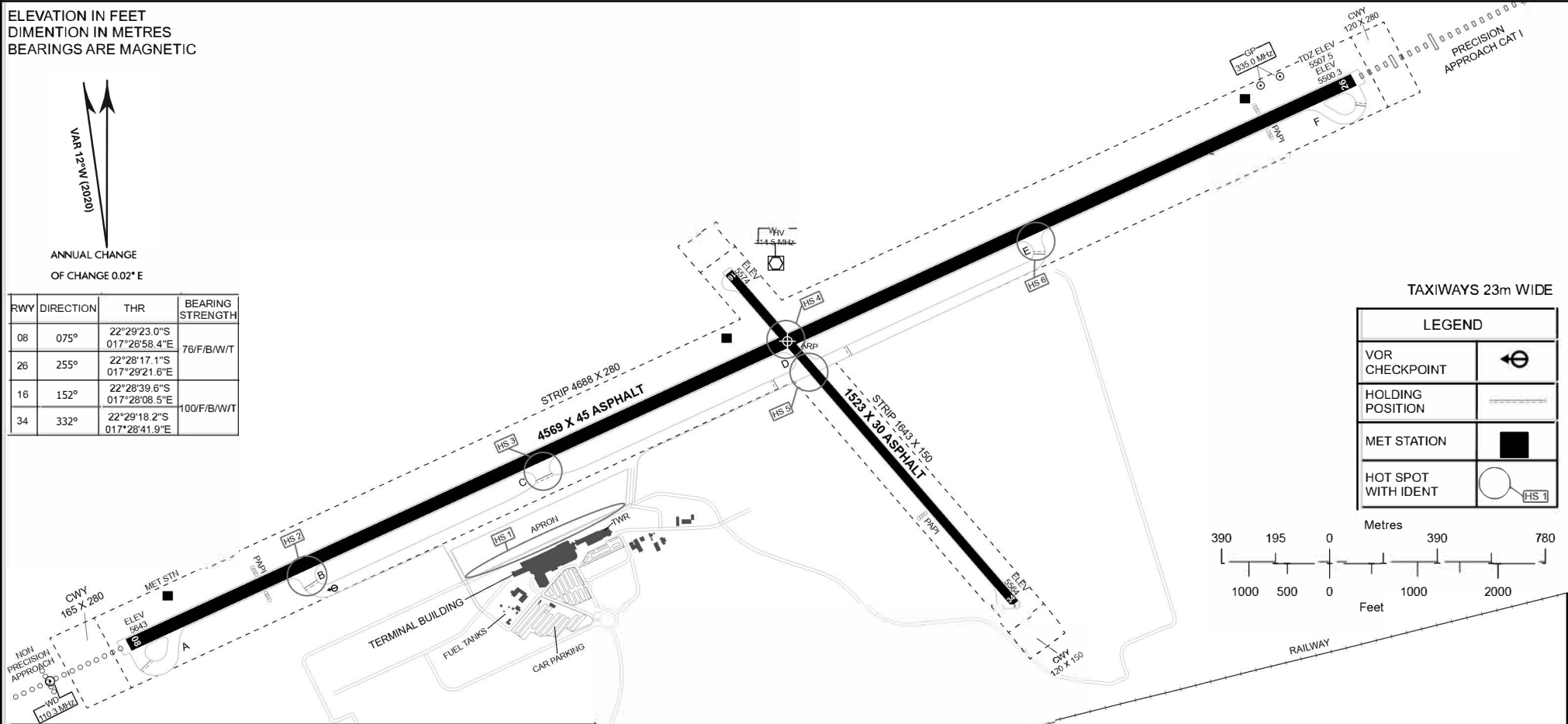

TAXIWAYS 23m WIDE

LEGEND	
VOR CHECKPOINT	
HOLDING POSITION	
MET STATION	
HOT SPOT WITH IDENT	

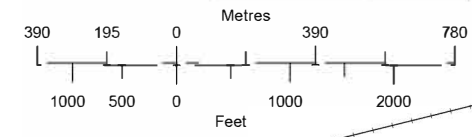

MARKING AIDS RWY 08/26 AND EXIT TWY

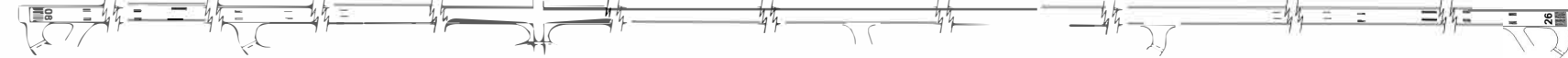

LIGHTING AIDS RWY 08/26 AND EXIT TWY



MARKING AIDS RWY 16/34 AND EXIT TWY



LIGHTING AIDS RWY 16/34 AND EXIT TWY

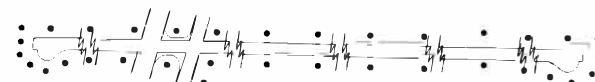

INTENTIONALLY LEFT BLANK

AERODROME OBSTACLE CHART ICAO
TYPE A (OPERATING LIMITATIONS)

WINDHOEK/ Hosea Kutako Intl Airport

RWY 08 / 26

DIMENSIONS AND ELEVATIONS IN METRES

MAGNETIC VARIATION 12°W - JAN 2020

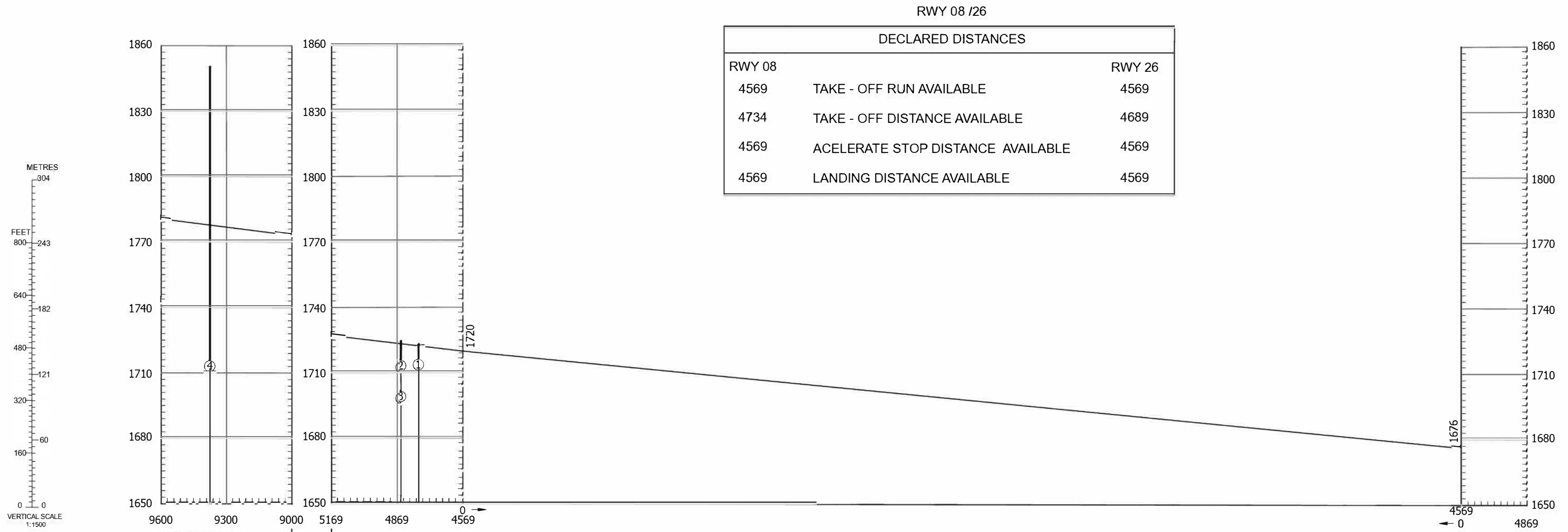

RWY 08 / 26		
DECLARED DISTANCES		
RWY 08		RWY 26
4569	TAKE - OFF RUN AVAILABLE	4569
4734	TAKE - OFF DISTANCE AVAILABLE	4689
4569	ACCELERATE STOP DISTANCE AVAILABLE	4569
4569	LANDING DISTANCE AVAILABLE	4569

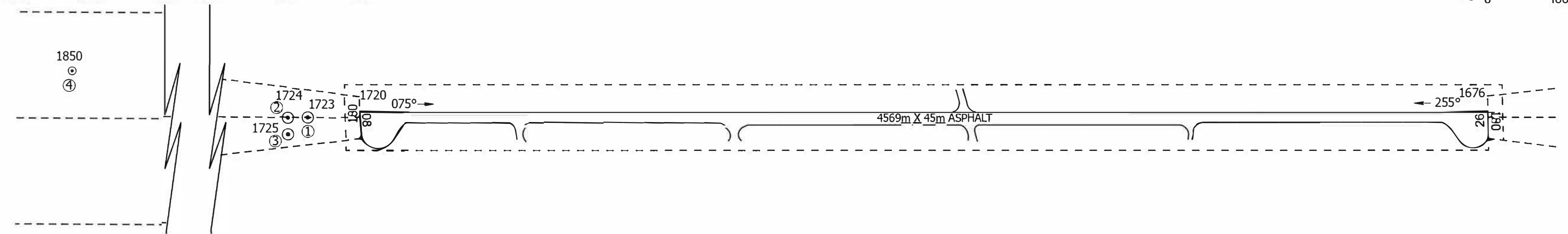

LEGEND	
IDENTIFICATION NUMBER	①
LOCALIZER, ILS MONITOR, POWER TRANSMISSION LINE	⊙

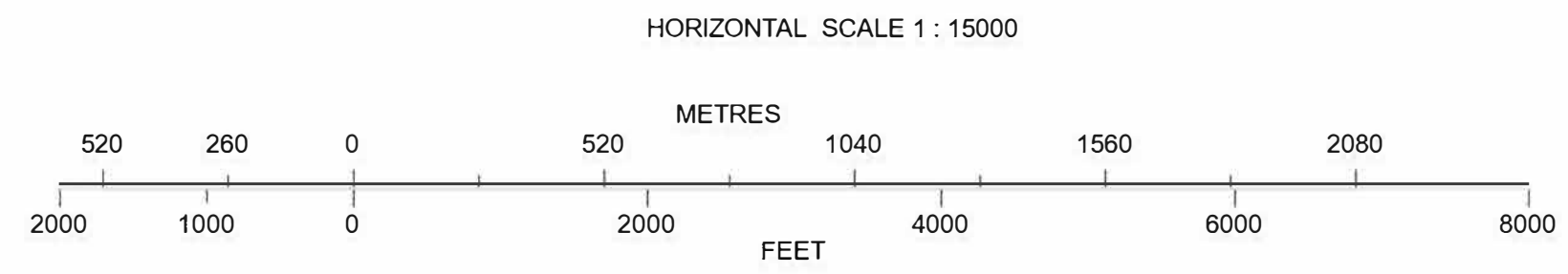

INTENTIONALLY LEFT BLANK